

B-B

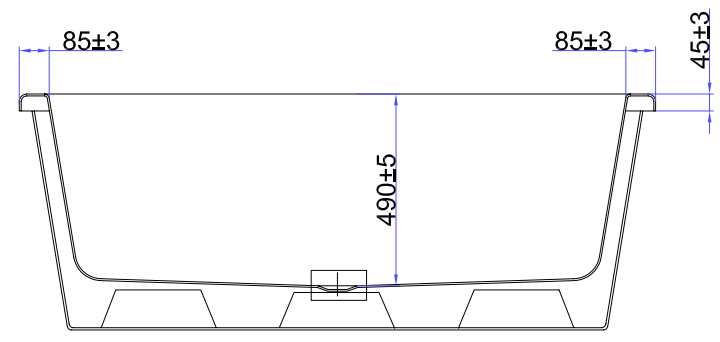

A-A

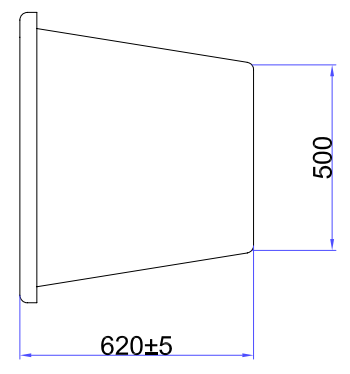
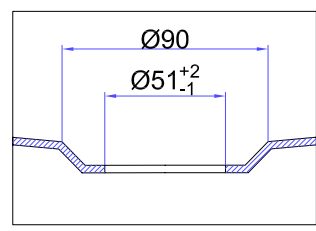

C-C

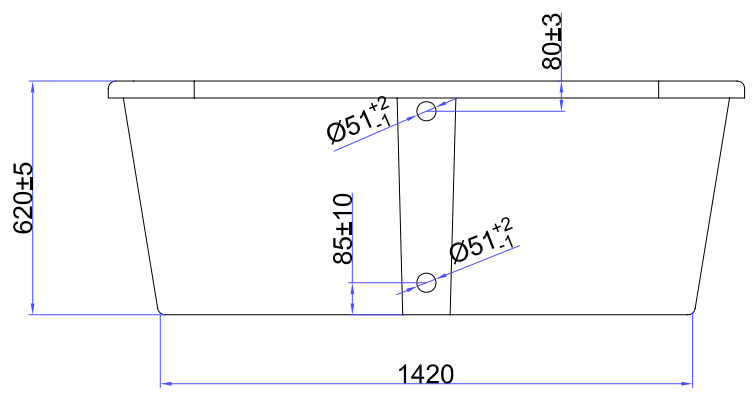

Bath Water Volume : 215 litres * / 145 litres **

* Volume of water contained in the bath if filled to the overflow.

** Volume of water contained in the bath if filled to the overflow less 70 litres displacement to allow for an average person in the bath.

Product weight: 42kg